

MONTÁŽNÍ NÁVOD MADLA DLOUHÁ

LUSY, DENY, ANDY, ENTERO, ENTERO II

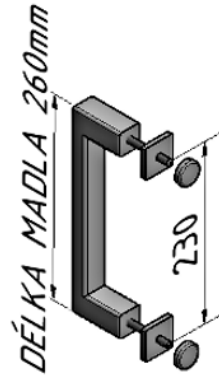
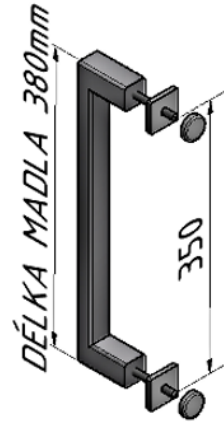
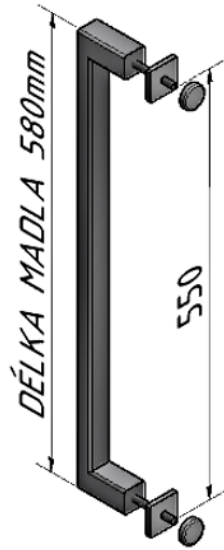
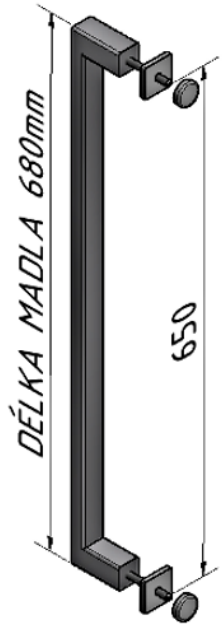

PŘÍKLAD VRTÁNÍ PRO MADLO ROZTEČ 230mm

NA SKLENĚNÉ DVEŘE

NA DŘEVĚNÉ DVEŘE

NA DŘEVĚNÉ DVEŘE

DO SLEPÉ DÍRY

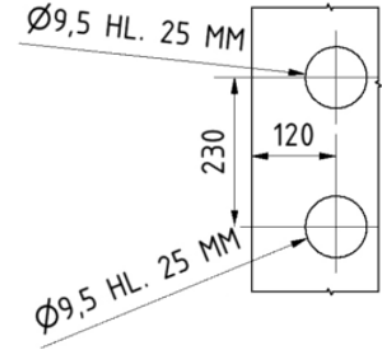
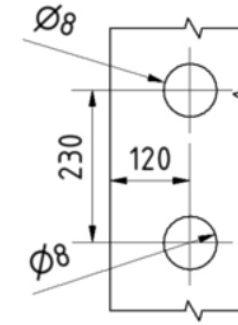
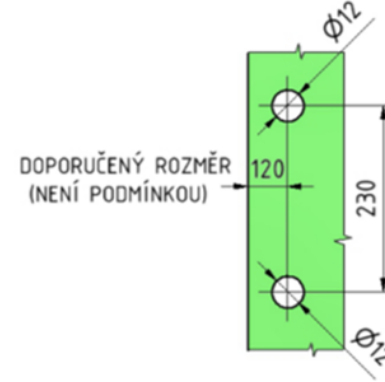

MADLA DODÁVÁME
NEBO

JEDNOSTRANNÁ

VARIANTA NA SKLO

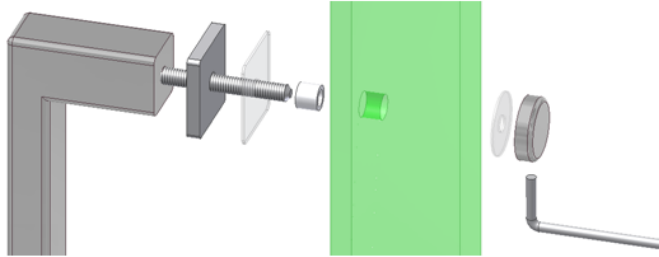

OBOUSTRANNÁ

VARIANTA NA SKLO

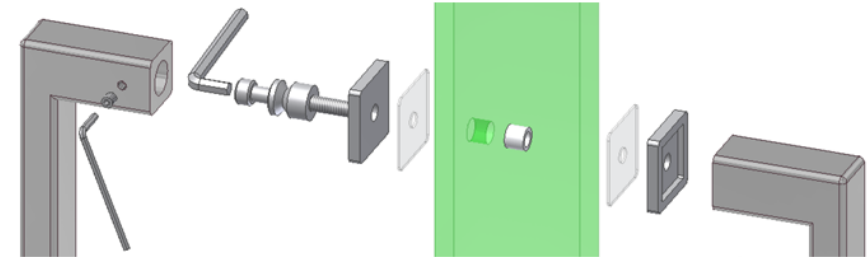

VARIANTA NA DŘEVĚNÉ DVEŘE

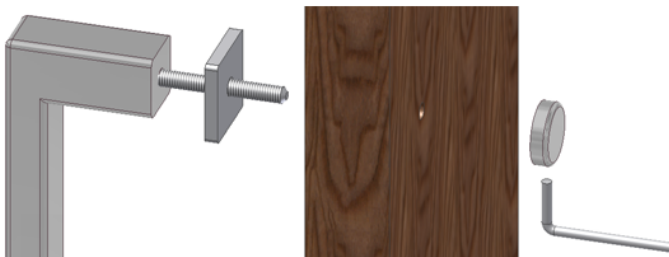

VARIANTA NA DŘEVĚNÉ DVEŘE DO SLEPÉ DÍRY

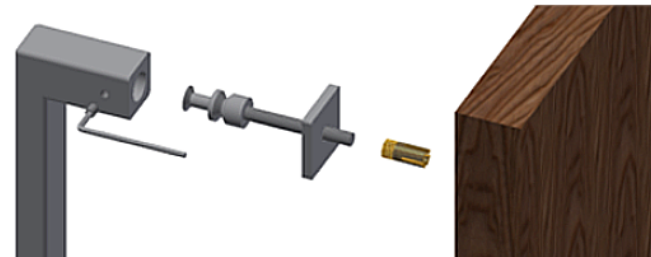

VARIANTA NA DŘEVĚNÉ DVEŘE

